

kogelkopanker 2.5t

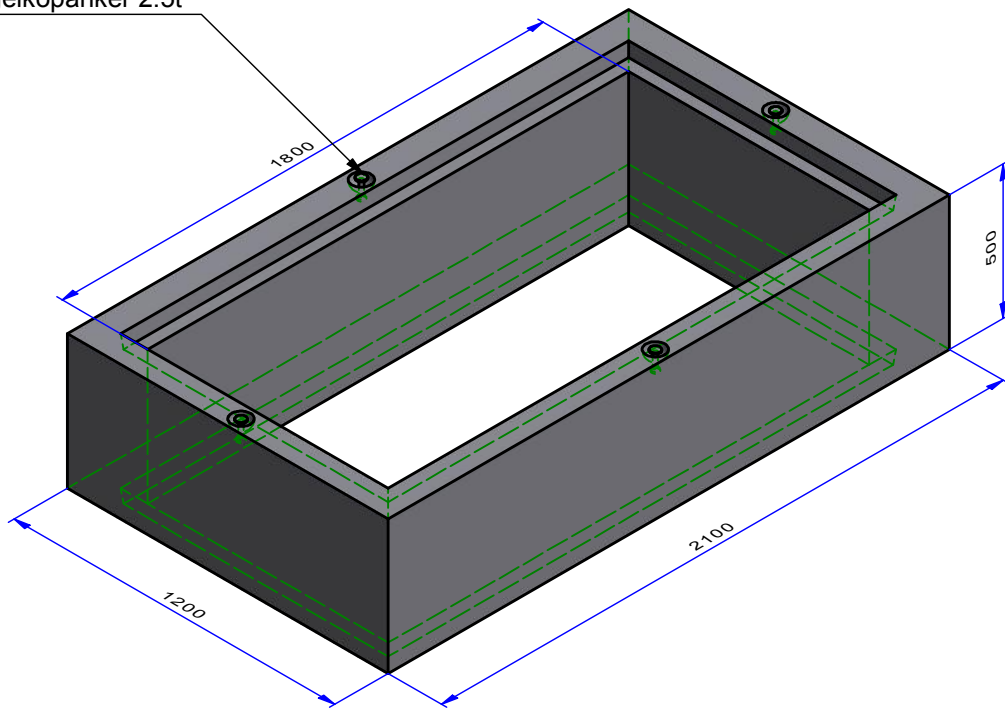

omschrijving/description

**Opzetstuk 210.120.50 in 180.90.50**

**Rehausse 210.120.50 in 180.90.50**

artikelnr/nr article

**2460210**

gewicht/poids

1079 kg

kwaliteit beton / qualité du béton

C40/50

doc nr

2460210

datum/date

2/03/2017

schaal/echelle

1/20

maateenheid/unité

mm

staalkwaliteit/qualité de l'acier

BE50S / BE500ES