

kogelkopanker 2.5t

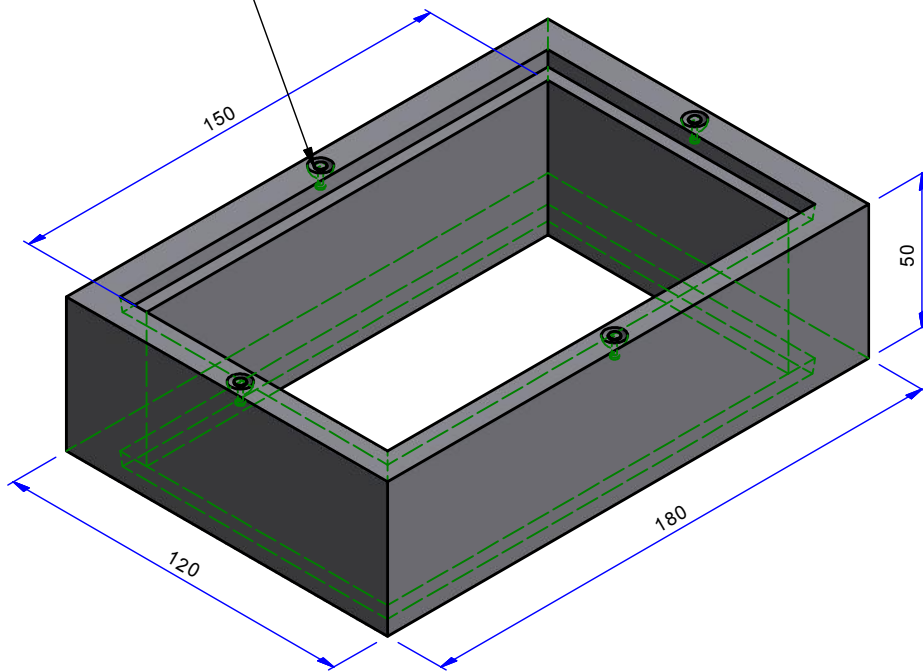

omschrijving/description

Opzetstuk 180.120.50 in 150.90.50

Rehausse 180.120.50 in 150.90.50

artikelnr/nr article

2460160

gewicht/poids

971 kg

kwaliteit beton / qualité du béton

C40/50

doc nr

2460160

datum/date

2/03/2017

schaal/echelle

1/20

maateenheid/unité

mm

staalkwaliteit/qualité de l'acier

BE500S / BE500ES