

kogelkopanker 2.5t

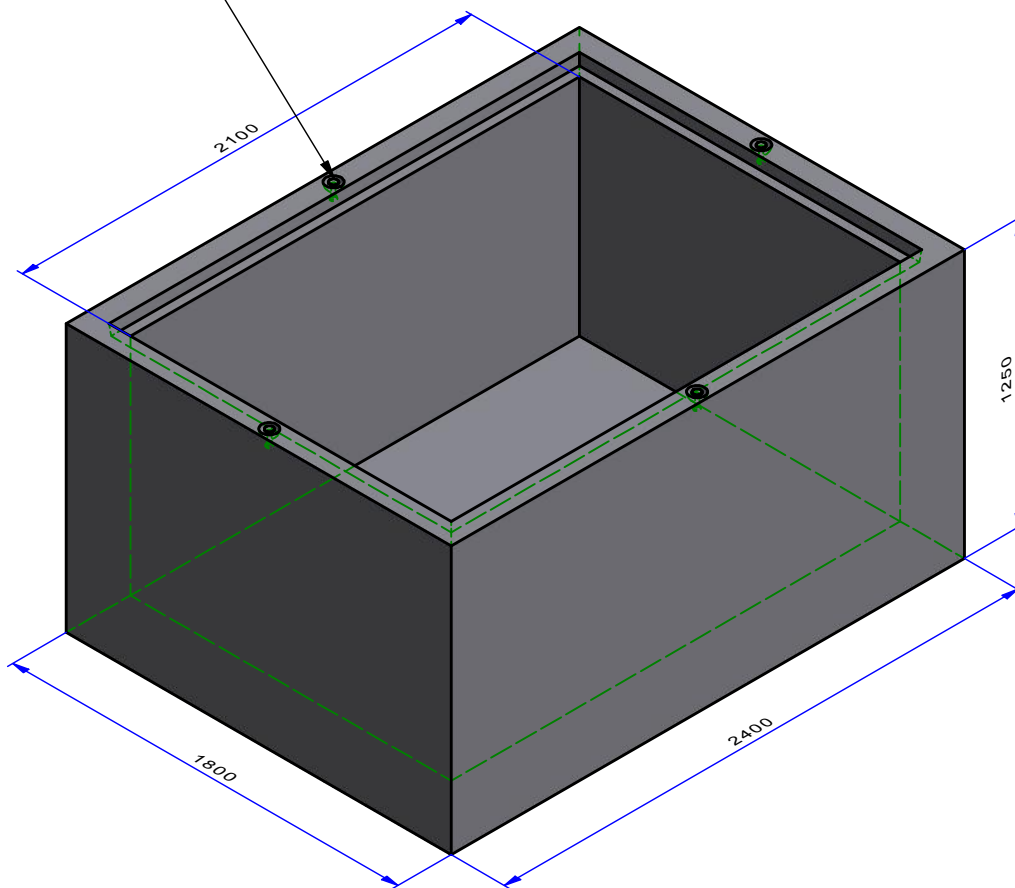

omschrijving/description

Put 240.180.125 in 210.150.110

Chambre 240.180.125 in 210.150.110

artikelnr/nr article

2460550

gewicht/poids

4601 kg

kwaliteit beton / qualité du béton

C40/50

doc nr

2460550

datum/date

2/03/2017

schaal/echelle

1/25

maateenheid/unité

mm

staalkwaliteit/qualité de l'acier

BE500S / BE500ES