

kogelkopanker 2.5t

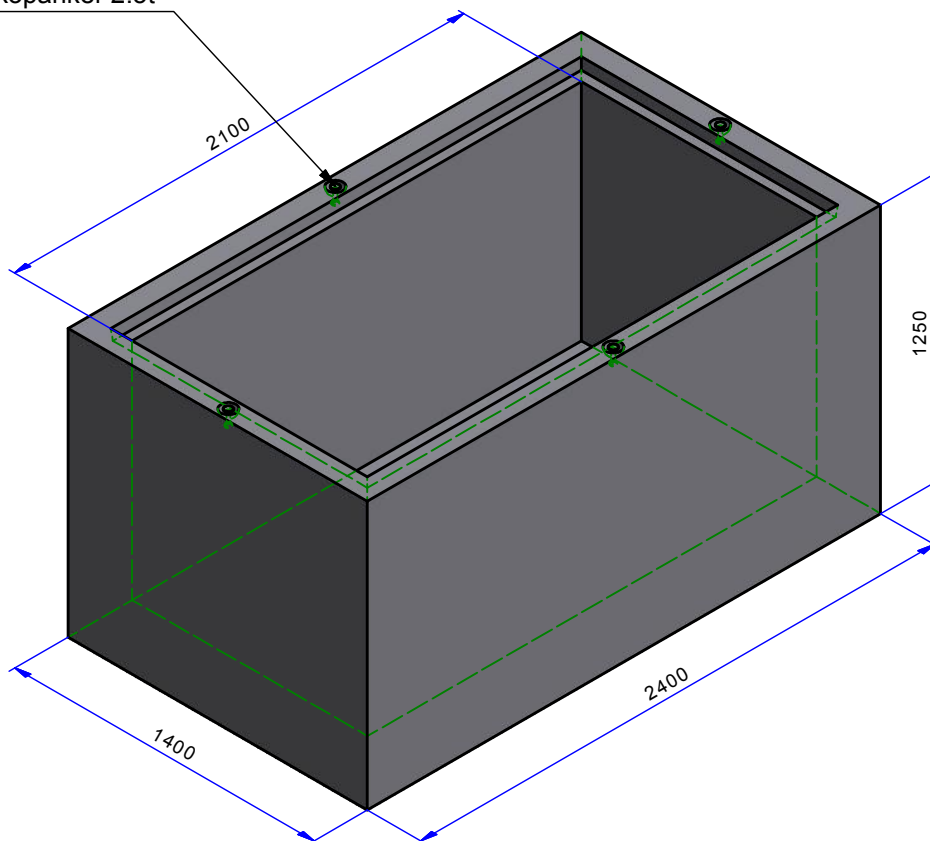

omschrijving/description

Put 240.140.125 in 210.110.110

Chambre 240.140.125 in 210.110.110

artikelnr/nr article

2460450

gewicht/poids

3943 kg

kwaliteit beton / qualité du béton

C40/50

doc nr

2460450

datum/date

2/03/2017

schaal/echelle

1/25

maateenheid/unité

mm

staalkwaliteit/qualité de l'acier

BE500S / BE500ES