

kogelkopanker 2.5t

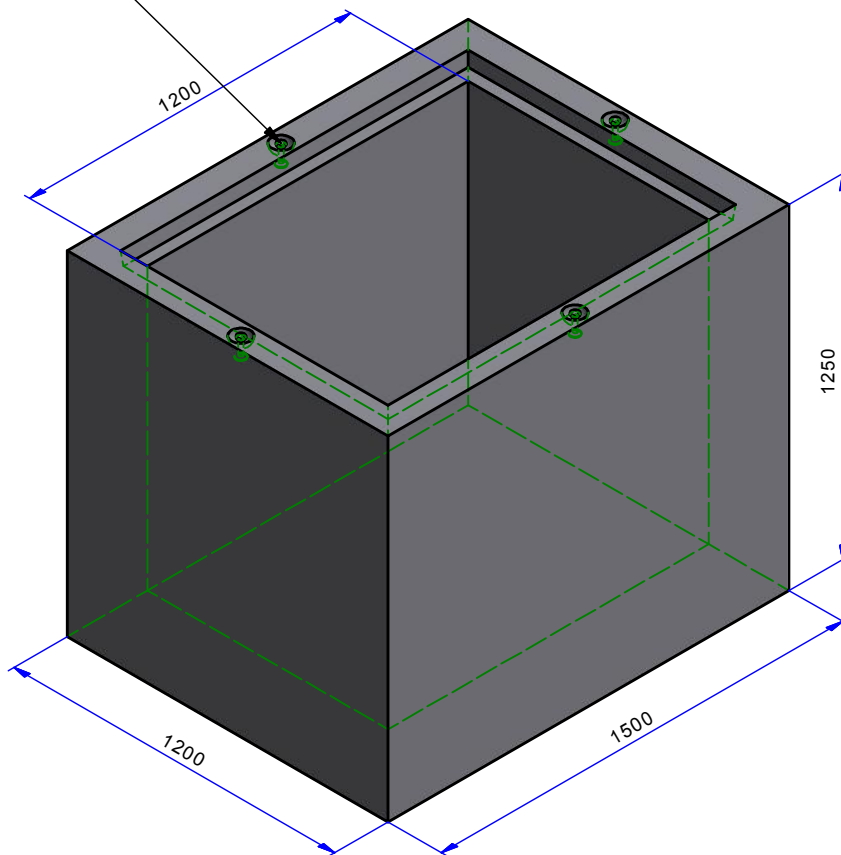

omschrijving/description

Put 150.120.125 in 120.90.110

Chambre 150.120.125 in 120.90.110

artikelnr/nr article

2460100

gewicht/poids

2523 kg

kwaliteit beton / qualité du béton

C40/50

doc nr

2460100

datum/date

2/03/2017

schaal/echelle

1/20

maateenheid/unité

mm

staalkwaliteit/qualité de l'acier

BE500S / BE500ES