

kogelkopanker 2.5t

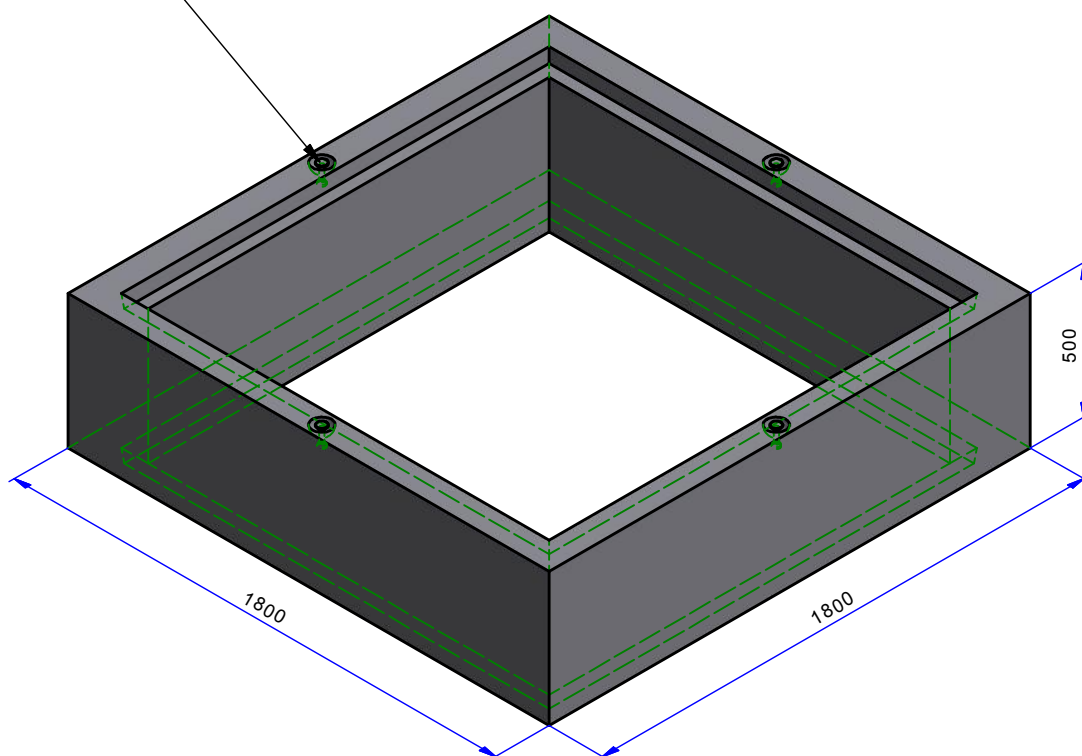

Wapening / armature: Ø8 #150/150



omschrijving/description

**Opzetstuk 180.180.50 in 150.150.50**

**Rehausse 180.180.50 in 150.150.50**

artikelnr/nr article

**2480120**

gewicht/poids

1187 kg

kwaliteit beton / qualité du béton

C40/50

doc nr

2480120

datum/date

20/02/2018

schaal/echelle

1/20

maateenheid/unité

mm

staalkwaliteit/qualité de l'acier

BE500S / BE500ES