

kogelkopanker 2.5t

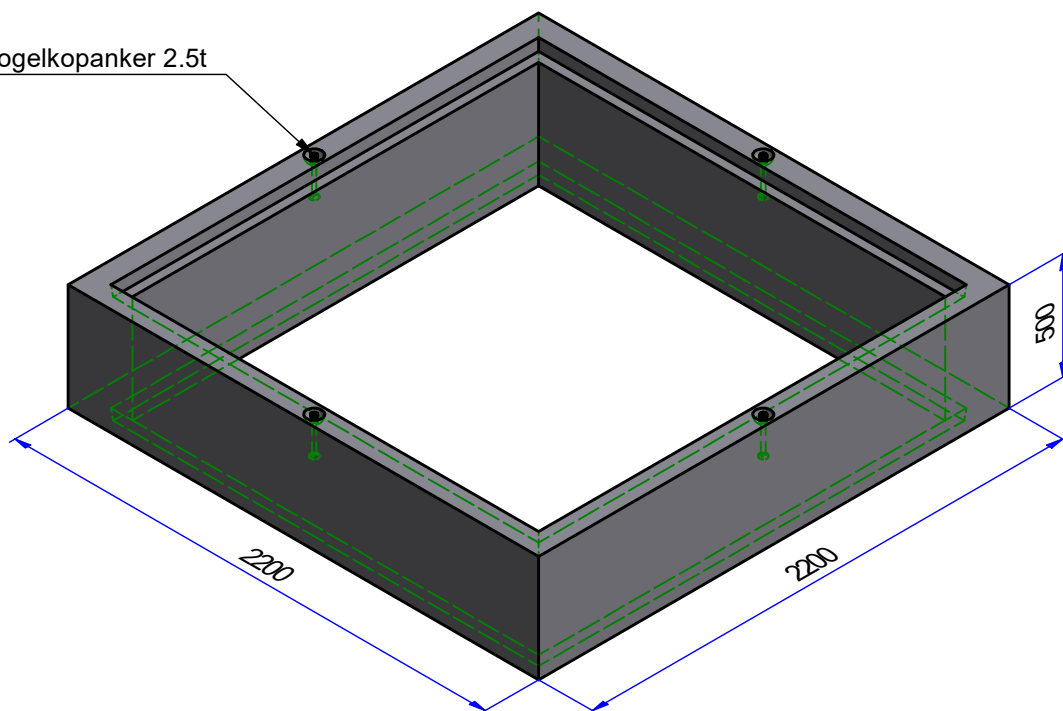

Wapening / armature: Ø8 #150/150



omschrijving/description

Opzetstuk 220.220.50 in 190.190.50

Rehausse 220.220.50 in 190.190.50

artikelnr/nr article

2480510

gewicht/poids

1476 kg

kwaliteit beton / qualité du béton

C40/50

doc nr

2480510

datum/date

21/12/2017

schaal/echelle

1/25

maateenheid/unité

mm

staalkwaliteit/qualité de l'acier

BE500S / BE500ES