

kogelkopanker 2.5t

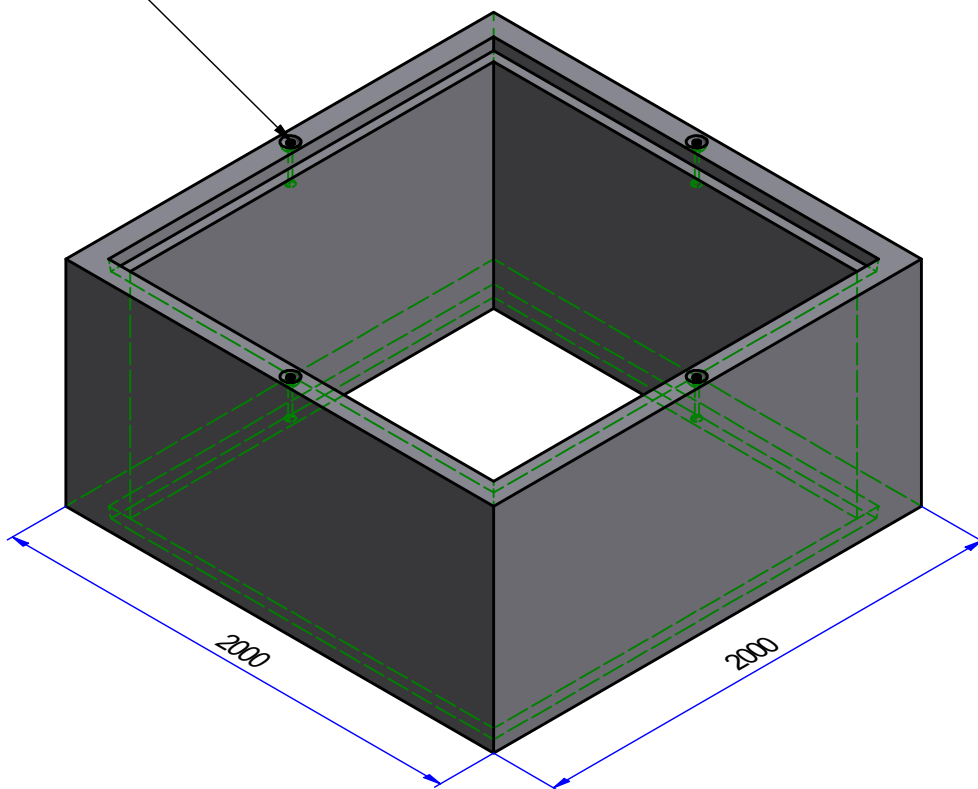

Wapening / armature: Ø8 #150/150



omschrijving/description

**Opzetstuk 200.200.100 in 170.170.100**

**Rehausse 200.200.100 in 170.170.100**

artikelnr/nr article

**2480320**

gewicht/poids

2664 kg

kwaliteit beton / qualité du béton

C40/50

doc nr

2480320

datum/date

21/12/2017

schaal/echelle

1/25

maateenheid/unité

mm

staalkwaliteit/qualité de l'acier

BE500S / BE500ES