

kogelkopanker 2.5t

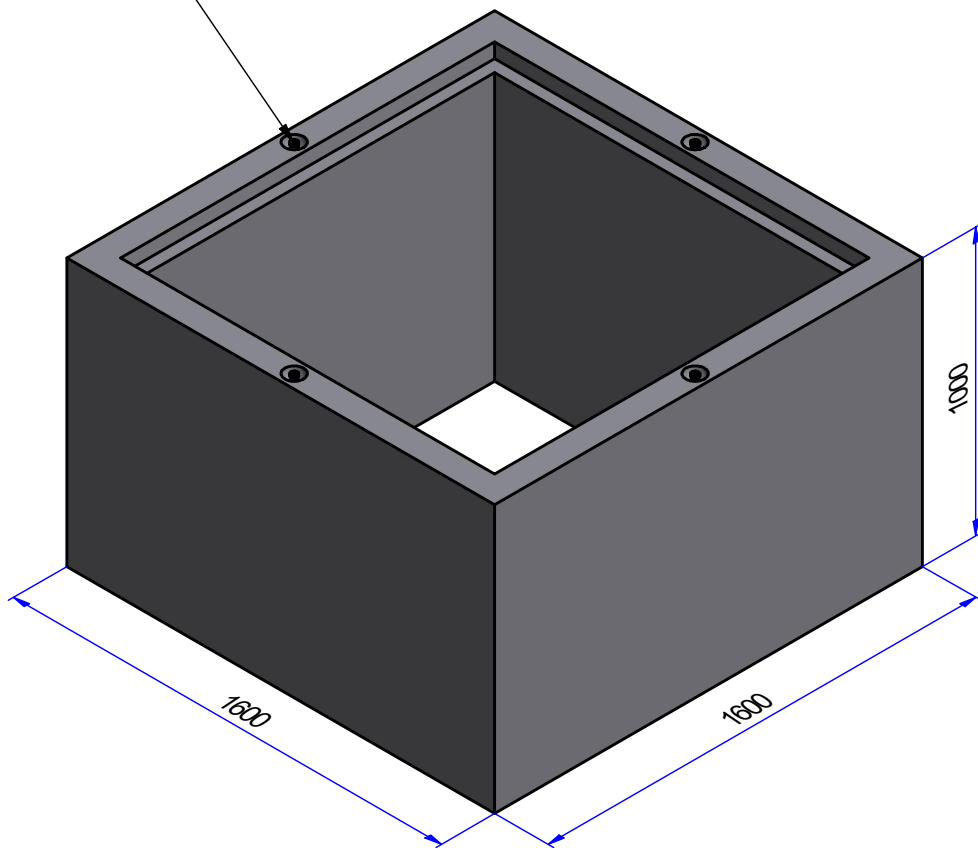

Wapening / armature: Ø8 #150/150



omschrijving/description

Opzetstuk 160.160.100 in 130.130.100

Rehausse 160.160.100 in 130.130.100

artikelnr/nr article

2470220

gewicht/poids

2088 kg

kwaliteit beton / qualité du béton

C40/50

doc nr

2470220

datum/date

4/02/2021

schaal/echelle

1/20

maateenheid/unité

mm

staalkwaliteit/qualité de l'acier

BE500S / BE500ES