

kogelkopanker 2.5t

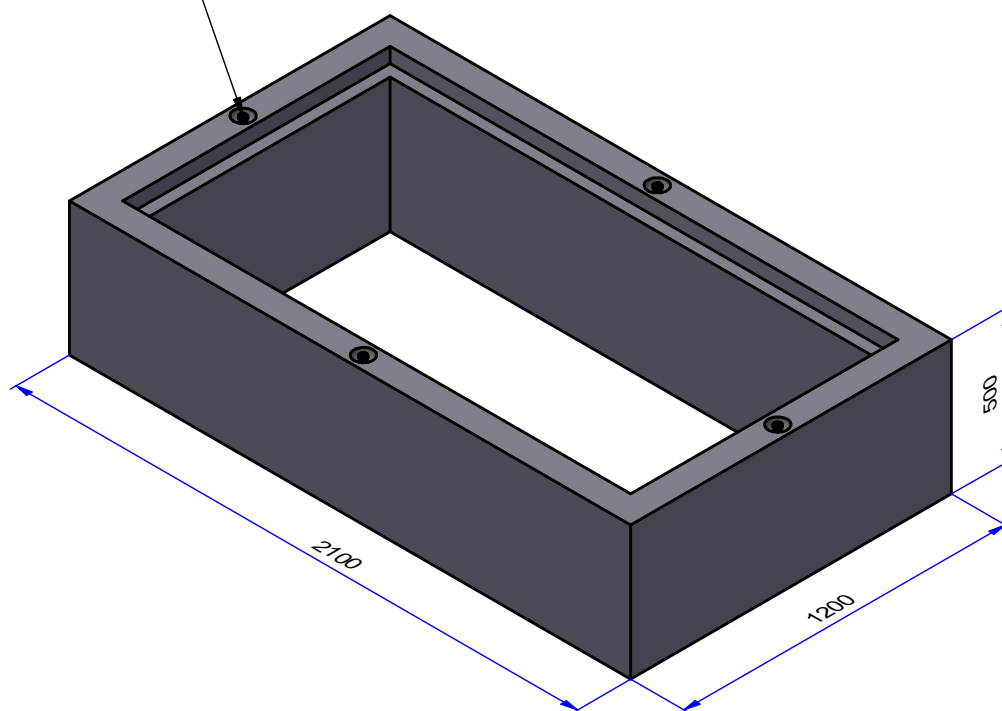

Wapening / armature: Ø8 # 150/150



omschrijving/description

Opzetstuk 210.120.50 in 180.90.50

Rehausse 210.120.50 in 180.90.50

artikelnr/nr article

2460260

gewicht/poids

1080 kg

kwaliteit beton / qualité du béton

C40/50

doc nr

2460260

datum/date

2/03/2017

schaal/echelle

1/20

maateenheid/unité

mm

staalkwaliteit/qualité de l'acier

BE50S / BE500ES