

kogelkopanker 2.5t

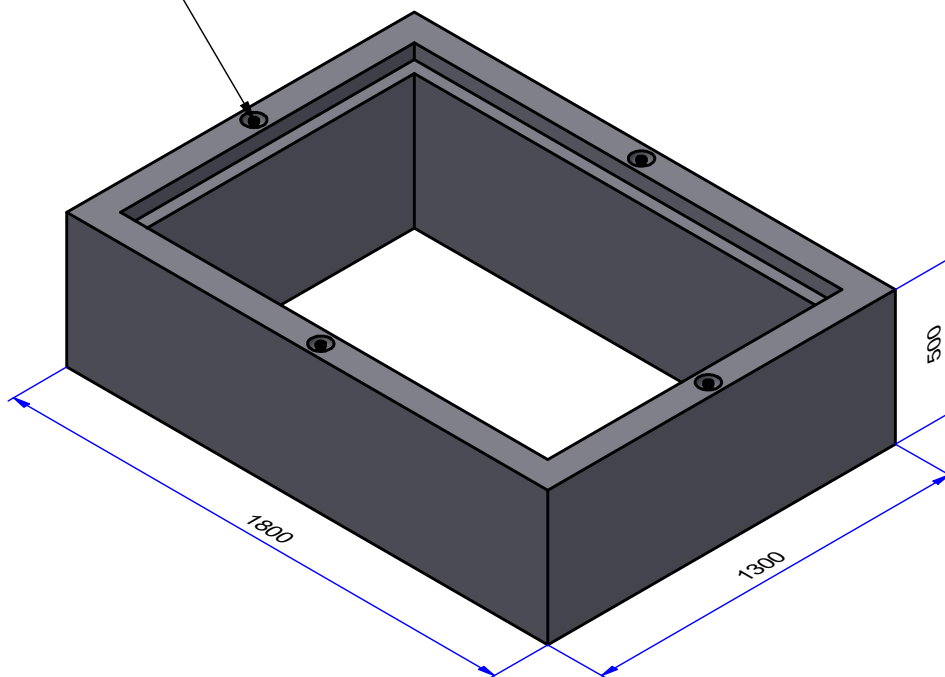

Wapening / armature: Ø8 # 150/150



omschrijving/description

Opzetstuk 180.130.50 in 150.100.50

Rehausse 180.130.50 in 150.100.50

artikelnr/nr article

2460210

gewicht/poids

1008 kg

kwaliteit beton / qualité du béton

C40/50

doc nr

2460210

datum/date

2/02/2021

schaal/echelle

1/20

maateenheid/unité

mm

staalkwaliteit/qualité de l'acier

BE500S / BE500ES